

SEADOG[®] LINE

QUALITY MARINE GEAR

2019 & 2018 SUPPLEMENT



Signature
4/13

Sea-Dog does not sell to the general public – we only sell to boat builders and wholesalers. For information on how to purchase our products, visit the "Where to Buy" page on our website.

To Order

To place an order, please contact us in one of the following ways (e-mail preferred for order accuracy):

E-mail orders@sea-dog.com
Phone 425-259-0194
Toll Free 866-732-3641
Fax 425-339-1345
OEM Customer Service custservo@sea-dog.com
After Market Cust. Service custserva@sea-dog.com
Artwork & Photography graphics@sea-dog.com
Operations operations@sea-dog.com
Website sea-dog.com

Minimum Orders

Orders less than \$100 incur a \$10 handling fee. For maximum cost effectiveness, we recommend each item's standard packaging quantities are maintained.

There is a \$10 surcharge for all drop ship orders.

Returns

A Return Goods Authorization (RGA) number must be obtained prior to any return. Credit will not be issued for goods returned without prior authorization. Special order items cannot be returned. Include the following with your return:

1. List of returned items
2. Invoice number with Sea-Dog order number and date of purchase
3. Reason for return

Return items are subject to a minimum 20% restocking charge and must be ready for resale in original packaging. Customer is responsible for shipping charges of their return. Address returns to:

Sea-Dog Corporation
3402 Smith Avenue
Everett, WA 98201 USA

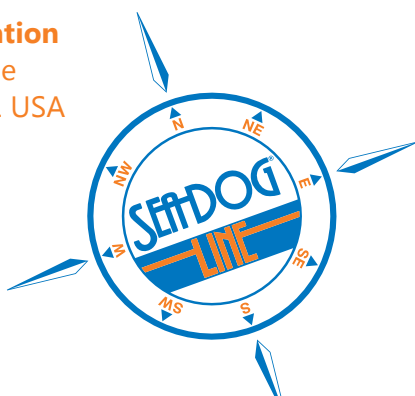

-1s, -2s, -3s, & -5s

Items available in retail display packaging are identified with a -1, -2, -3, and -5 after the Sea-Dog part number. More specifically:

- 1 Hanging card, bagged with header card, or in a clamshell
- 2 Higher quantity display packaging
- 3 Full color box
- 5 Point of Purchase (POP) display: clear container with set number of that item.

Why are Proposition 65 warnings in our Sea-Dog catalog?

We at Sea-Dog strive to do the right thing as a responsible manufacturer. While no changes have been made to our products that have been in our catalog for years, and even though the Prop 65 label is only a California requirement, Sea-Dog Line, out of an abundance of caution, is labeling all Prop 65 items regardless of their intended destination.

So, as part of California's Right to Know, you will see Prop 65 warnings on some of our product packaging, in our catalog, and on our web site.

Prop 65 was enacted in 1986 for California only. Its intent was to protect drinking water sources from being contaminated with chemicals known to cause cancer, birth defects, or other reproductive harm. Since its inception, it has grown to include approximately 1000 chemicals, many of which are found in common household items.

Labeled products for Sea-Dog predominantly fall into three categories as pertains to Prop 65: Those containing brass, those with a galvanized finish, or those containing PVC. All brass contains lead, as does galvanizing solution. PVC, commonly used in wiring products, contains vinyl chloride. Both of these substances are listed as chemicals known to the state of California to cause cancer or reproductive toxicity.

For additional information on Prop 65 visit:
www.P65Warnings.ca.gov

Two-Year Supplement

Normally, in odd years we publish a full catalog so we thought a quick note was needed to explain that for 2019 we are publishing a supplement for new items added in 2019. However, we also included our new for 2018 items so you will have new items from both 2019 and 2018 in a combined two-year supplement. You do not need to keep your 2018 supplement but please keep your 2017 catalog so you will have all the great Sea-Dog items we offer. We will once again publish a full catalog in 2020.

Pictures, Pictures, Pictures

You are probably wondering why all the pictures on the cover and no waterfront scene. Taking an idea from our 1979 catalog when the company was actually Sneve Nysether Inc. (see picture to the right), we decided to show a few pictures of who we are and what we do. The patriarch (Eldon M. Nysether) in his favorite chair; the forklift. One big shipment all wrapped in orange shrink wrap and prepped for pick up. Some of our many plastic injection molding machines from our sister company, also located in Everett Washington, which allows us to proudly say made in the USA. A couple of our employees in our award winning packaging department operating a blister pack machine. From our stainless steel foundry partner, a small part of the investment casting process; molten stainless steel being poured into the ceramic tree. Last, but not least, is the stern of the original 1955 Sea-Dog, following our tradition of including the Sea-Dog boat in the usual waterfront scene.



SEADOG[®]LINE
QUALITY MARINE GEAR

A PART OF BOAT BUILDING
FOR OVER 90 YEARS





T-HINGE

Investment Cast 316 Stainless Steel

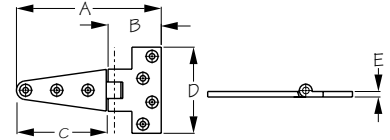

Bulk	Display	A	B	C	D	E	Fastener	Wt.(lb.)	Std. Pack
205705	n/a	4"	1-1/2"	2-1/2"	2-3/8"	1/8"	#8 FH	.17	10 ea
205710	n/a	6"	1-3/4"	4-1/4"	3-1/8"	1/8"	#10 FH	.37	10 ea

A T-hinge is a hybrid combination between a butt and strap hinge. The vertical part of the T goes on the frame, while the horizontal part is fastened to the door or cabinet and is visible when closed. This hinge is surface mounted, not recessed, and can be used on doors, cabinets, dock boxes, ice chests, etc. Corrosion resistant 316 stainless steel construction makes this T-hinge both highly decorative and functional.



LIFT GATE BUTT HINGE

Aluminum

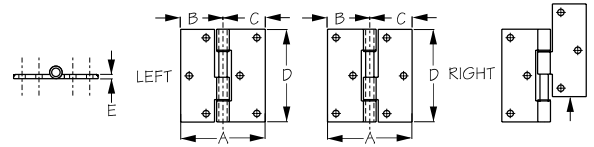

Bulk	Display	A	B	C	D	E	Side	Fastener	Wt.(lb.)	Std. Pack
207730	207730-1	2-1/2"	1-1/4"	1-1/4"	2-3/4"	1/8"	Left	#10 RH	.11/.22	10 ea / 10 pr
207735	207735-1	2-1/2"	1-1/4"	1-1/4"	2-3/4"	1/8"	Right	#10 RH	.11/.22	10 ea / 10 pr

Aluminum pontoon lift gate hinge with nylon washers for quiet movement and smooth operation.



DOOR HANDLE LATCH

Investment Cast 316 Stainless Steel

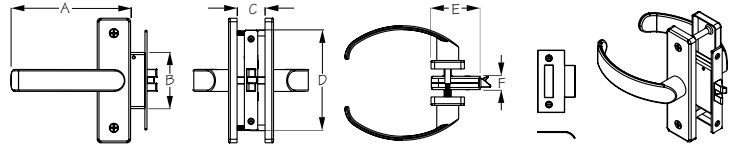

Bulk	Display	A	B	C	D	E	F	Fastener	Wt.(lb.)	Std. Pack
n/a	221610-1	4-1/8"	2"	3/4"-1-1/2"	3-9/16"	1-3/4"	7/16"	#8 FH	.98	1 ea

Constructed of corrosion resistant 316 stainless steel, for a modern, sleek look. Includes strike plate and mounting template. For doors 3/4" - 1-1/2" thick.



T-HANDLE LOCKING COMPRESSION LATCH

Investment Cast 316 Stainless Steel

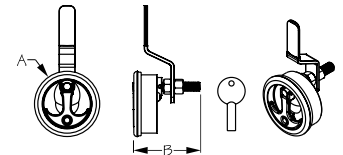

Bulk	Display	A	B	Locking	Cutout Hole Size	Max. Depth	Wt.(lb.)	Std. Pack
221982L	221982L-1	2-7/16"	2-1/2"	Yes	2"	2"	.96	1 ea

This heavy-duty compression latch features a T-handle to engage the offset locking arm and the compression feature. Investment cast 316 stainless steel construction for corrosion resistance and durability. The handle is recessed for a flush, clean installation. Locking feature for secure hatches, includes heavy duty stainless key. Requires a 2" size cutout hole and installs with a back mounted stainless cup.



PUSH BUTTON CABINET LATCH

Investment Cast 316 Stainless Steel/Chrome Plated Brass

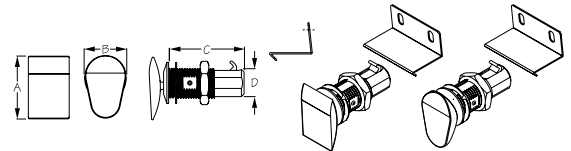

Bulk	Display	Style	A	B	C	D	Wt.(lb.)	Std. Pack
225400	225400-1	Oval	1-7/16"	15/16"	1-11/16"	3/4"	.20	5 ea
225420	225420-1	Rectangular	1-7/16"	15/16"	1-11/16"	3/4"	.21	5 ea

These corrosion resistant 316 stainless steel cabinet latches function as both a latch and handle. Push button operation activates and secures the latch with a simple, deliberate motion. Positive action locking function prevents cabinets from opening while in motion. Easy installation - single 3/8" hole to bore. Suitable for left or right-hand side uses. Sleek low-profile design makes them convenient in tight spaces. Great for glove compartments. Includes catch.

⚠ WARNING: Cancer and Reproductive Harm - www.P65Warnings.ca.gov

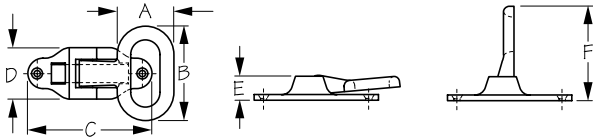

FOLDING STEP

Sand Cast Brass Chrome Plated



Bulk	Display	A	B	C	D	E	F	Fastener	Wt.(lb.)	Std. Pack
322622	n/a	2"	3-1/4"	4-5/16"	1-13/16"	13/16"	3-7/16"	1/4" FH	1.10	5 ea

▲ **WARNING:** Cancer and Reproductive Harm - www.P65Warnings.ca.gov

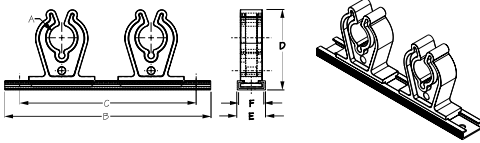

TRACK ROD HOLDER

Aluminum/PVC



Bulk	Display	A	B	C	D	E	F	Kit Includes	Wt.(lb.)	Std. Pack	
n/a	325044-1	7/8"	7"	5-7/8"	2-7/8"	13/16"	15/16"	2 Tracks/4 Clips	.48	4 ea	
325040	n/a	Aluminum Track Section Only (6 ft. total length)								3.00	10 ea
325041	n/a	Clip Only								.08	10 ea

Includes two 7" pre-drilled aluminum tracks and four PVC clips. These racks are designed to hold fishing rods safely in the toughest conditions. Can be mounted vertically or horizontally in boats and homes. Mounting screws included.

▲ **WARNING:** Cancer and Reproductive Harm - www.P65Warnings.ca.gov

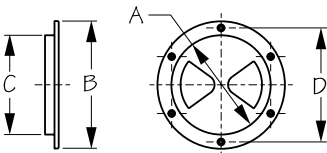

SCREW-OUT DECK PLATE

Injection Molded Polypropylene



Bulk	Display	A	B	C	D	Color	Fastener	Wt.(lb.)	Std. Pack
335740	335740-1	4-7/16"	5-3/4"	4-1/2"	5-1/8"	White	#8 FH	.19	10 ea / 5 ea
335760	335760-1	6-1/2"	8-1/8"	6-1/2"	7-1/4"	White	#8 FH	.44	10 ea / 5 ea

Sea-Dog® deck plates are molded to the highest standards using top quality UV stabilizers and antioxidants. When installing, use silicone sealant on hull or deck surface. Keep threads clean with hot soapy water. Lubricate with Vaseline or Teflon grease.

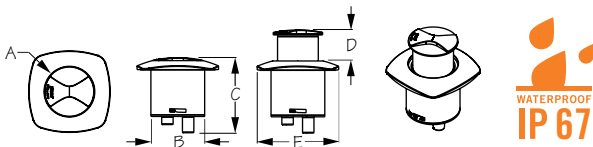

LED COMBINATION POP-UP BOW LIGHT

Investment Cast 316 Stainless Steel/ABS



Bulk	Display	Light Arc	A	B	C	D	E	Fastener	Wt.(lb.)	Std. Pack
n/a	400054-3	10 pts	2-3/8"	2-5/8"	3-7/8"	1-3/8"	3-15/16"	#10 FH	.50	1 ea



A simple twist of the cap allows the light to pop up, ready to use when it's switched on. Push the cap down, twist to lock, and light disappears into the deck. The LED Combination Pop-Up Bow Light is approved for USCG 2 NM (Colreg 2 mile). Investment cast stainless steel cap and bezel. IP67 waterproof rating.

Note: All USCG approved navigation lights must be mounted properly to provide the correct visual alignment and allow unimpeded sight lines. Please refer to United States Coast Guard regulations for 1 NM and 2 NM navigation lights for more information.

▲ **WARNING:** Cancer and Reproductive Harm - www.P65Warnings.ca.gov

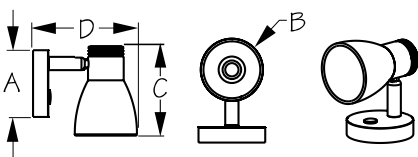

LED CABIN/READING LIGHT WITH TOUCH DIMMER

Brushed Aluminum



Bulk	Display	A	B	C	D	Voltage	Finish	Fastener	Wt.(lb.)	Std. Pack
n/a	400710-3	2-1/2"	2-3/8"	3-3/8"	4"	10-24	Brushed	#6 FH	.43	5 ea

Built-in touch controlled on/dim/off switch, the light provides a direct beam reading light as well as ambient light for the cabin. High quality aluminum construction with an adjustable light angle and a warm white, 3000K Cree bulb providing 270 lumens at 2W. Works with 12V and 24V systems. Includes mounting screws and Allen wrench.

▲ **WARNING:** Cancer and Reproductive Harm - www.P65Warnings.ca.gov



LED ALCOR COURTESY LIGHT

Investment Cast 316 Stainless Steel

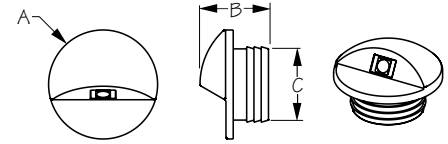

Bulk	Display	A	B	C	Voltage	Color	LEDs	Wt.(lb.)	Std. Pack
401412	401412-1	1-1/2"	1"	1"	12	White	1	.12	5 ea
401413	401413-1	1-1/2"	1"	1"	12	Blue	1	.12	5 ea

Available in blue or white, this high quality 1-1/2" diameter round light with one LED bulb can be mounted to cast light down, to the side, or straight up, depending on the required application.

⚠ WARNING: Cancer and Reproductive Harm - www.P65Warnings.ca.gov

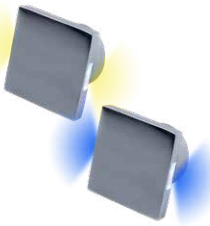

LED SQUARE COURTESY LIGHT

Investment Cast 316 Stainless Steel

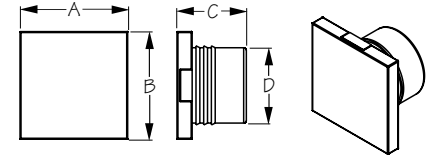

Bulk	Display	A	B	C	D	Voltage	Color	LEDs	Wt.(lb.)	Std. Pack
401417	401417-1	1-3/8"	1-3/8"	15/16"	1"	12	White	2	.14	5 ea
401418	401418-1	1-3/8"	1-3/8"	15/16"	1"	12	Blue	2	.14	5 ea

Available in blue or white, this high quality 1-3/8" square light with two LED bulbs can be mounted to cast light up and down or side to side, depending on the required application.

⚠ WARNING: Cancer and Reproductive Harm - www.P65Warnings.ca.gov



DELUXE LED COURTESY LIGHT - LARGE

Plastic/Investment Cast 316 Stainless Steel

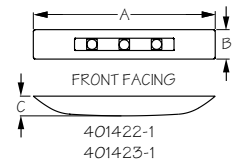

Bulk	Display	A	B	C	Lumens	Voltage	Color	Facing	Wt.(lb.)	Std. Pack
401422	401422-1	3-15/16"	11/16"	7/16"	20	9-28	White	Forward	.08	5 ea

Modern streamlined profile. This light provides outward directed light from three white, low amperage, long life LED bulbs with 20 lumens output. IP67 waterproof rating. 9 – 28VDC.

⚠ WARNING: Cancer and Reproductive Harm - www.P65Warnings.ca.gov



LED STRIP LIGHT

Plastic

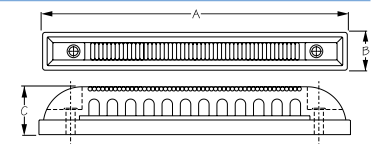

Bulk	Display	A	B	C	LEDs	Voltage	Color	Fastener	Wt.(lb.)	Std. Pack
401445	401445-1	3-15/16"	3/4"	15/16"	6	12/24	White	#10 RH	.06	5 ea
401446	401446-1	3-15/16"	3/4"	15/16"	6	12/24	Blue	#10 RH	.06	5 ea

LED strip lights are constructed of corrosion resistant lightweight plastic. These lights feature 6 low amp draw LEDs per light. Installs with two #10 RH fasteners (included). Circuit boards are epoxy potted for an IP67 waterproof seal. 12/24VDC.

⚠ WARNING: Cancer and Reproductive Harm - www.P65Warnings.ca.gov



LED LOW PROFILE TASK LIGHT WITH TOUCH ON/DIM/OFF SWITCH

304 Stainless Steel

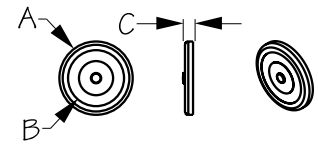

Bulk	Display	A	B	C	Ring Finish	Voltage	LED Color	Fastener	Wt.(lb.)	Std. Pack
n/a	401686-1	2-3/4"	2-1/16"	5/16"	Polished	12-28	White	#6 FH	.08	5 ea

Surface mounted light constructed of corrosion resistant 304 stainless steel. Features 24 LEDs, warm white @ 0.19A/143 lumens. Integral touch on/dim/off switch with memory. Activate by pressing the center button. IP65 rating. CE approved. 12-28VDC.

⚠ WARNING: Cancer and Reproductive Harm - www.P65Warnings.ca.gov

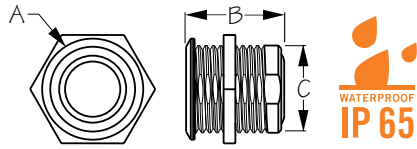

LED ON/OFF SWITCH

304 Stainless Steel



Bulk	Display	A	B	C	Max Amps	Voltage	Wt.(lb.)	Std. Pack
403063	403063-1	7/8"	7/8"	3/4"	5	10-24	.25	5 ea / 4 ea

Comes prewired for ease of installation. Typically wired so LED ring lights up blue when circuit is energized. IP65 rating.

⚠ WARNING: Cancer and Reproductive Harm - www.P65Warnings.ca.gov

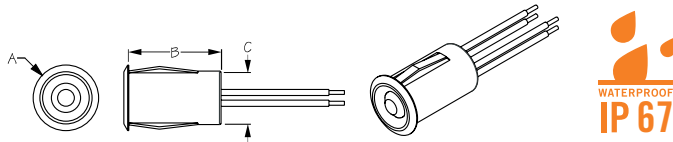

MOTION SENSOR SWITCH

ABS



Bulk	Display	A	B	C	Max Amps	Voltage	Wt.(lb.)	Std. Pack
403066	403066-1	1-1/16"	1-9/16"	7/8"	5	10-30	.25	5 ea

Motion sensor switch can be used to activate LED and incandescent lights. The motion detection range is up to 16 feet, with an activation angle of 120 degrees. The factory preset activated time is 60 seconds. 2A, 12V/24VDC. IP67 waterproof rating.

⚠ WARNING: Cancer and Reproductive Harm - www.P65Warnings.ca.gov

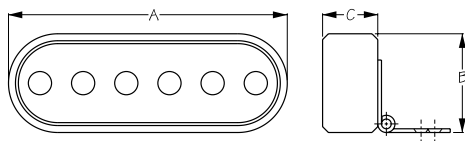

LED COMPACT FLOOD LIGHT

Aluminum/304 Stainless Steel



Bulk	Display	A	B	C	LEDs	Amps	Volts	Lumens	Wt.(lb.)	Std. Pack
n/a	405350-3	6"	2-1/8"	1-3/16"	6	1.25	10-30	1400	.77	1 ea



Machined solid aluminum body with anodized finish provides sleek look and durability. Six 3W LEDs, 1400 lumens and 60° flood light. Includes stainless steel pivoting mounting bracket. 10~30VDC, 1.25A@12V. 15W.

⚠ WARNING: Cancer and Reproductive Harm - www.P65Warnings.ca.gov

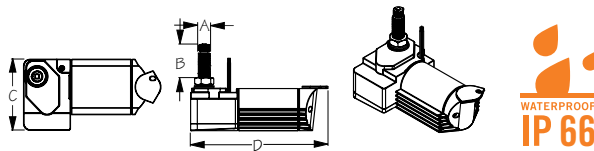

WATERPROOF HEAVY DUTY WIPER MOTOR

Powder Coated Aluminum/304 Stainless Steel



New Color!



Bulk	Display	Finish	Sweep	(Shaft Dia.)	(Shaft Len.)	C	D	Volts/Amps	Wt.(lb.)	Std. Pack
n/a	412211B-3	Black	110°	5/8"	1-1/2"	4"	7-1/2"	12/2	3.20	1 ea
n/a	412218B-3	Black	80°	5/8"	1-1/2"	4"	7-1/2"	12/2	3.20	1 ea
n/a	412221B-3	Black	110°	5/8"	2-1/2"	4"	7-1/2"	12/2	3.20	1 ea
n/a	412228B-3	Black	80°	5/8"	2-1/2"	4"	7-1/2"	12/2	3.20	1 ea
n/a	412231B-3	Black	110°	5/8"	3-1/2"	4"	7-1/2"	12/2	3.20	1 ea
n/a	412238B-3	Black	80°	5/8"	3-1/2"	4"	7-1/2"	12/2	3.20	1 ea

Two-speed, self-parking heavy-duty motors for exterior/unprotected locations. Sweep angle is preset at 80° or 110°, but can be reset to 40°, 50°, 60°, 70°, 80°, 90° or 110°. Powder coated all aluminum housing with stainless steel mounting bracket, shaft, and knurled fitting. Adjustable right or left hand park, factory preset for left-hand park. Powers up to a 24" arm and blade configuration (36" total length). IP66 rating (dust tight and protected from strong jets of water). CE approved. 3-year warranty.

⚠ WARNING: Cancer and Reproductive Harm - www.P65Warnings.ca.gov

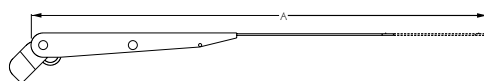

PREMIUM WIPER ARM FOR STANDARD MOTORS

Formed 304 Stainless Steel

Bulk	Display	A	Shaft Size	Finish	Wt.(lb.)	Std. Pack
n/a	413054B-1	9-1/2" - 12-1/2"	3/8"	Black	.41	12 ea

Premium stainless steel wiper arm for use on standard motors (412321B-3, 412328B-3) and waterproof standard wiper motors (412321W-3, 412328W-3) with 3/8" shaft diameter.





OLED TEMPERATURE METER

Injection Molded Nylon

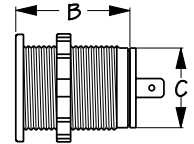
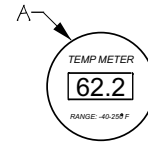

Bulk	Display	A	B	C	Volts	Temp Range	Wt.(lb.)	Std. Pack
421610	421610-1	1-7/16"	3/4"	1-1/8"	12-24	-67°F to 248°F	.02	5 ea

Designed to withstand constant vibration and the rigors of a wet marine environment. Monitors temperature on a bright, waterproof, daylight readable OLED (Organic LED) screen. High contrast and resolution, visible from a wide viewing angle, visible with polarized sunglasses. Reverse polarity protected. Same compact round size as a standard 12V receptacle, this OLED temperature meter provides many installation options. Injection molded nylon construction. Includes a prewired temperature sensor with a 6' cable. IP66 rating.

⚠ WARNING: Cancer and Reproductive Harm - www.P65Warnings.ca.gov



OLED 100 AMP METER

Injection Molded Nylon

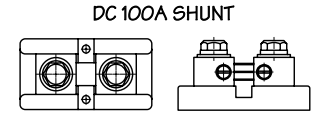
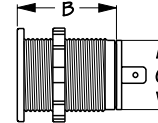
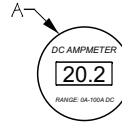

Bulk	Display	A	B	C	Volts	Amp Range	Wt.(lb.)	Std. Pack
421620	421620-1	1-7/16"	3/4"	1-1/8"	12-24	100	.02	5 ea

Designed to withstand constant vibration and the rigors of a wet marine environment. Monitors amperage on a bright, waterproof, daylight readable OLED (Organic LED) screen. High contrast and resolution, visible from a wide viewing angle, visible with polarized sunglasses. Reverse polarity protected. Same compact round size as a standard 12V receptacle, this OLED amp meter provides many installation options. Injection molded nylon construction. IP66 rating. Includes 100A/50mV shunt.

⚠ WARNING: Cancer and Reproductive Harm - www.P65Warnings.ca.gov



DUAL VOLT/AMP METER ROCKER SWITCH STYLE

Injection Molded Nylon

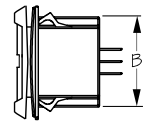
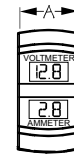

Bulk	Display	A	B	Volts	Amps	Wt.(lb.)	Std. Pack
421645	421645-1	13/16"	1-7/16"	4-30	10	.04	5 ea

This rocker switch style dual volt/amp meter monitors and displays the voltage and amps simultaneously. Fits into any 13/16" X 1-7/16" rocker switch hole. Digital red LED display. Input 10-48VDC. IP65 rating.

⚠ WARNING: Cancer and Reproductive Harm - www.P65Warnings.ca.gov



WATER RESISTANT TOGGLE SWITCH PANEL WITH USB POWER SOCKET

Injection Molded ABS/Polycarbonate

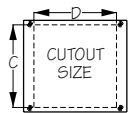
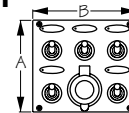

Bulk	Display	A	B	C	D	No. of Switches	Wt.(lb.)	Std. Pack
n/a	424617-1	4"	4-5/16"	3-3/8"	3-3/8"	5	.69	1 ea

Includes five switches rated at 15A 12VDC with blue LED indicator lights, blue LED lighted double USB power socket, ATC fuse holders and decal sheet. USB power socket output is 4.8A, 2.4A per side. Rated IP66.

⚠ WARNING: Cancer and Reproductive Harm - www.P65Warnings.ca.gov



WATER RESISTANT TOGGLE SWITCH PANEL WITH LED POWER SOCKET

Injection Molded ABS/Polycarbonate

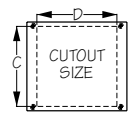
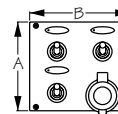

Bulk	Display	A	B	C	D	No. of Switches	Wt.(lb.)	Std. Pack
n/a	424623-1	4"	4-5/16"	3-3/8"	3-3/8"	3	.50	1 ea

Includes three switches rated at 15A 12VDC with blue LED indicator lights, blue LED lighted power socket, ATC fuse holders and decal sheet. Rated IP66.

⚠ WARNING: Cancer and Reproductive Harm - www.P65Warnings.ca.gov

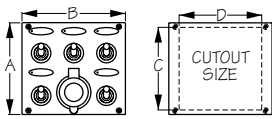

WATER RESISTANT TOGGLE SWITCH PANEL WITH LED POWER SOCKET

Injection Molded ABS/Polycarbonate



Bulk	Display	A	B	C	D	No. of Switches	Wt.(lb.)	Std. Pack
n/a	424627-1	4"	4-5/16"	3-3/8"	3-3/8"	5	.69	1 ea

Includes five switches rated at 15A 12VDC with blue LED indicator lights, blue LED lighted power socket, ATC fuse holders and decal sheet. Rated IP66.

⚠ WARNING: Cancer and Reproductive Harm - www.P65Warnings.ca.gov

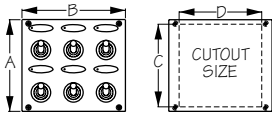

WATER RESISTANT TOGGLE SWITCH PANEL

Injection Molded ABS/Polycarbonate



Bulk	Display	A	B	C	D	No. of Switches	Wt.(lb.)	Std. Pack
n/a	424636-1	4"	4-5/16"	3-3/8"	3-3/8"	6	.70	1 ea

Includes six switches rated at 15A 12VDC with blue LED indicator lights, ATC fuse holders and decal sheet. Rated IP66.

⚠ WARNING: Cancer and Reproductive Harm - www.P65Warnings.ca.gov

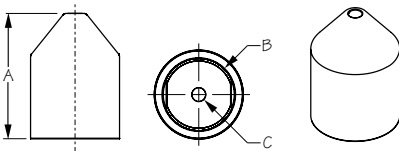

POWER SOCKET REAR BOOT

PVC



Bulk	Display	A	B	C	Wt.(lb.)	Std. Pack
426106	426106-1	1-7/8"	1-1/8"	1/4"	.03	10 ea / 5 ea

Fits all 1-1/8" power sockets and power socket meters. Protects wire connections and provides a finished appearance.

⚠ WARNING: Cancer and Reproductive Harm - www.P65Warnings.ca.gov

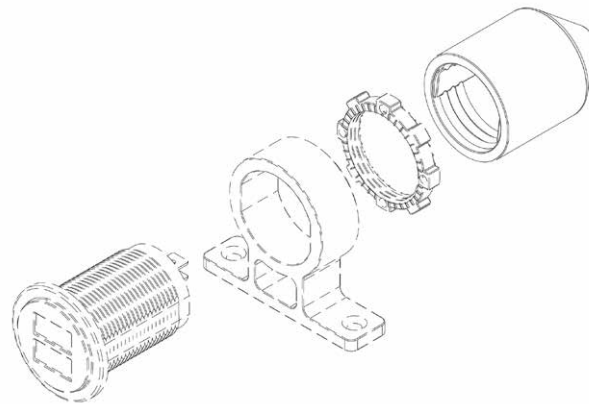

DOUBLE USB & POWER SOCKET PANEL WITH BREAKER SWITCH

Injection Molded Nylon

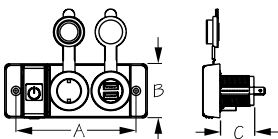

Bulk	Display	A	B	C	Voltage	Total Output	Wt.(lb.)	Std. Pack
n/a	426506-1	4-1/4"	2"	1-1/4"	12-24	5V/4.2A	.24	1 ea

This injection molded nylon power socket accommodates a LED lighted dual USB charger port, a LED lighted 12V power socket, and a lighted 16A circuit breaker switch. The circuit breaker switch allows the power to the lighted charger ports to be shut off to prevent battery drain. When the switch cover is completely closed, it automatically turns the switch off. The USB charger has a total output of 4.8A, with 2.4A per side, enough power to charge phones, pads, and tablets quickly and efficiently. The power socket is rated at a maximum of 12 volts/16 amps. Includes mounting screws and electrical connectors. Rated IP66.

⚠ WARNING: Cancer and Reproductive Harm - www.P65Warnings.ca.gov



DOUBLE USB POWER PLUG WITH VOLTAGE METER

Stamped Stainless/Injection Molded Nylon

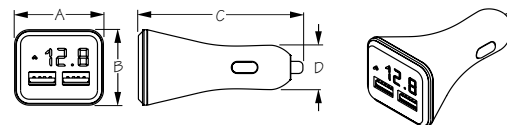

Bulk	Display	A	B	C	D	Voltage	Total Output	Wt.(lb.)	Std. Pack
426513	426513-1	1-1/2"	1-1/4"	2-13/16"	13/16"	12	5V/4.2A	.05	5 ea

This USB power plug adapter charges two devices simultaneously, providing DC 5V/2.4A per side, 4.8A total, which is more than enough power to charge phones, pads, and tablets quickly and efficiently. LED lighted amp meter window monitors voltage. For use on a boat or in a car or RV, this portable version fits all standard 12V receptacles, including all Sea-Dog power sockets. Stamped stainless steel and injection molded nylon construction.

⚠ WARNING: Cancer and Reproductive Harm - www.P65Warnings.ca.gov



PONTOON BOAT MINI COMPACT HORN WITH BRACKET

Powder Coated Steel/304 Stainless Steel

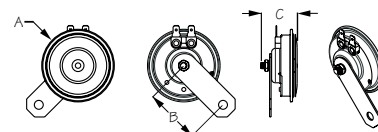

Bulk	Display	Amps	db	Frequency (Hz)	A	B	C	Wt.(lb.)	Std. Pack
431430	431430-1	4	111	370±20	2-13/16"	2-3/16"	1-7/16"	.35	12 ea / 6 ea

Designed for use on Pontoon boats and at 111 decibels and a frequency (Hz) of 370±20 this horn meets ABYC standard A-23. For use on vessels under 39'. 12VDC. Stainless bracket for easy mounting. Freshwater only.

⚠ WARNING: Cancer and Reproductive Harm - www.P65Warnings.ca.gov



MOTOR WELL BOOT - SPLIT

Molded Rubber

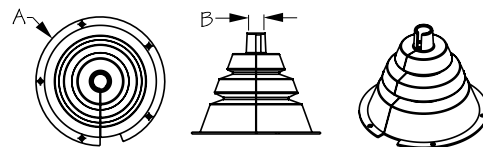

Bulk	Display	A	B	Fastener	Wt.(lb.)	Std. Pack
521663	521663-1	4-1/8"	1/2"	#8 RH	.13	10 ea / 5 ea
521664	521664-1	5-1/2"	9/16"	#8 RH	.23	10 ea / 5 ea

Black accordion style seal organizes and protects engine control cables, wires or fuel lines. UV stabilized molded rubber. Boots and rings are split for trouble free installation without removal of cables. Includes tie wrap.

⚠ WARNING: Cancer and Reproductive Harm - www.P65Warnings.ca.gov



REPLACEMENT ANVILS FOR MULTIPURPOSE CUTTER

Plastic

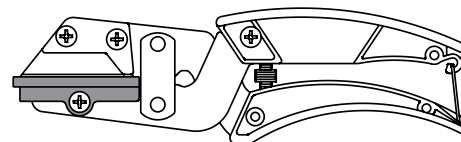

Bulk	Display	Description	Wt.(lb.)	Std. Pack
n/a	563311-1	Replacement Anvils	.03	1 pr

For replacement of the blue plastic anvils on the 563310-1 Multipurpose Cutter, sold in pairs.



POWER SOCKETS & GAUGES

#916056

With 19 of our leading 12V power sockets and USB charger ports, as well as volt and amp meters. This panel sets up the dealer with all of the products they need to serve the booming device charging market, along with gauges to monitor voltage use and amp draw. Stay ahead of the marketing curve by adding this panel to your store shelf.



Extended

⚠ **WARNING:** Cancer and Reproductive Harm
www.P65Warnings.ca.gov

Merchandise Panels

Sea-Dog's wide assortment of panels allow you to stock a variety of products in a particular category and provide a one-stop shop to meet your customer's needs.

All panels come pre-loaded with two each of every product on six inch hooks and back tags for every item.

COURTESY LIGHT DISPLAY

#916185

- Working LED courtesy light display with 29 working lights
- All lights are switch operated
- Comes with the 110V power pack installed – simply plug and play
- Display panel only – no saleable product



⚠ **WARNING:** Cancer and Reproductive Harm
www.P65Warnings.ca.gov

SOCKETS & GAUGES DISPLAY

#916186

Some top selling USB charging sockets and a voltmeter are mounted in a working panel. Prewired and supplied with a 110V 1A power source, just plug it in and be ready to demo these in demand products. Parts are labelled with item numbers.



⚠ **WARNING:** Cancer and Reproductive Harm
www.P65Warnings.ca.gov

Display Panels

Sea-Dog now offers fully operational panels to display our products. These eye catching panels will help you sell more, which helps us sell more, and we all win. Just add electricity.

If you take one of these on your boat...

YOU NEED ONE OF THESE!



- IP66 rating
- 12V/24V
- 4.8A output, 2.4A per side
- Fits round socket openings
- Fits rocker switch openings



Dual USB Power Outlet 426515-1

Dual USB Power Outlet w/ Hidden Voltmeter 426517-1

Dual USB Power Outlet Rocker Style 426520-1

Dual USB with Voltmeter Rocker Style 426527-1

DUAL USB POWER OUTLETS

HORNS



Quality and reliability you can count on from the factory that's been building marine horns for more than 55 years.



431430

MAX BLAST SINGLE MINI COMPACT HORN



431115

DROP-IN HIDDEN HORN WITH GRILLS



431250-1

MAX BLAST DUAL TRUMPET HORN



431520

SEA-DOG.COM

- IP66 rating
- 12V & 24V motors
- Adjustable park and sweep
- A full range of wiper blades and arms

WIPER PRODUCTS



World Class

316 STAINLESS STEEL HARDWARE

- A full range of top-of-the-line quality stainless steel items
- More than 100 different cleats with all sizes up to 24"
- Over 140 different styles and sizes of hinges
- Deck hardware
- Rod holders
- Shackles, snaps, and thimbles
- Vents
- And hundreds more





LIFT GATE BUTT HINGE

Aluminum

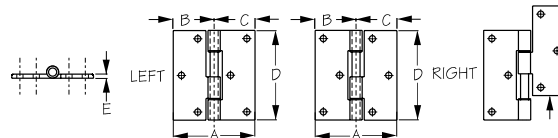

Bulk	Display	A	B	C	D	E	Side	Fastener	Wt.(lb.)	Std. Pack
207730	207730-1	2-1/2"	1-1/4"	1-1/4"	2-3/4"	1/8"	Left	#10 RH	.11 / .22	10 ea / 10 pr
207735	207735-1	2-1/2"	1-1/4"	1-1/4"	2-3/4"	1/8"	Right	#10 RH	.11 / .22	10 ea / 10 pr

Aluminum pontoon lift gate hinge with nylon washers for quiet movement and smooth operation.



LIFT HANDLE

Investment Cast 316 Stainless Steel

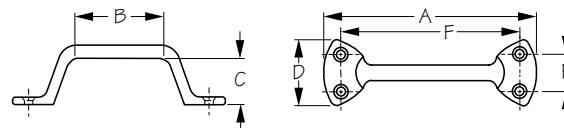

Bulk	Display	A	B	C	D	E	F	Fastener	Wt.(lb.)	Std. Pack
221275	221275-1	5-3/4"	2-5/8"	1-1/4"	1-11/16"	1"	4-13/16"	#10 FH	.29	5 ea



GRAB HANDLE

Injection Molded Nylon/PVC Coated

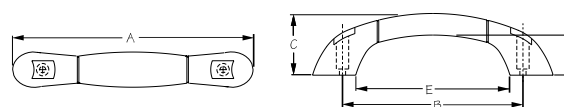

Bulk	Display	A	B	C	D	E	Color	Fastener	Wt.(lb.)	Std. Pack
227560	227560-1	9-3/4"	7-1/4"	2-1/2"	1-3/4"	6-1/4"	Black	#10 FH	.40	5 ea
227561	227561-1	9-3/4"	7-1/4"	2-1/2"	1-3/4"	6-1/4"	White	#10 FH	.40	5 ea

Soft grip, concealed fasteners. Fasteners included.

⚠ WARNING: Cancer and Reproductive Harm - www.P65Warnings.ca.gov



DELUXE HANDHELD ROPE CUTTER

Steel/Plastic

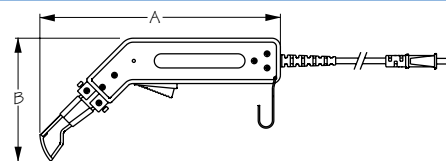

Bulk	Display	A	B	Voltage	Wt.(lb.)	Std. Pack
n/a	300095-3	10-1/2"	5-1/2"	120	3.80	1 ea

- Easily cuts nylon, polyester, polypropylene, and Dacron cordage and webbing
- Cuts and heat seals at the same time
- Replaceable blade heats to 1100° Fahrenheit (600° Celsius) in less than 10 seconds
- Brass bristle cleaning brush, T-handle Allen wrench, and carrying case included
- 10 ft Heavy-duty grounded cord
- 110V
- ETL listed

⚠ WARNING: Cancer and Reproductive Harm - www.P65Warnings.ca.gov



ECONOMY HAND HELD ROPE CUTTER/SOLDERING GUN

Steel/Plastic

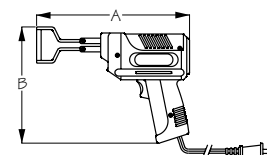

Bulk	Display	A	B	Voltage	Wt.(lb.)	Std. Pack
n/a	300097-3	9-1/4"	6-3/4"	120	1.65	1 ea

- Easily cuts nylon, polyester, polypropylene, Dacron cordage, and webbing
- Cuts and heat seals at the same time
- Includes replaceable blade and soldering tip
- UL listed

⚠ WARNING: Cancer and Reproductive Harm - www.P65Warnings.ca.gov

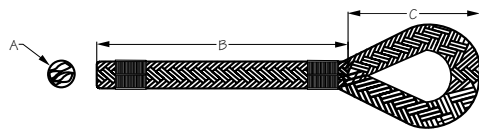

PREMIUM FENDER LINE

Double Braided Nylon

New Colors & Sizes!



Bulk	Display	A (Dia.)	B (Length)	C (Eye Size)	Color	WLL-kgs/lbs	B.S.-kgs/lbs	Wt.(lb.)	Std. Pack
n/a	302106006BG-1	1/4"	6'	2"	Burgundy	132/290	660/1330	.64	12 pr
n/a	302110006BG-1	3/8"	6'	3"	Burgundy	376/825	1880/3800	.64	12 pr

Double Braided Fender Line

- 100% premium double braided nylon, sold in pairs
- Professional double braided nylon splice
- Yacht whipped at bitter end and splice point
- Available in a wide range of colors and sizes
- Comes in an attractive reclosable clamshell package

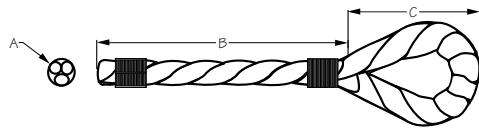

DOCK LINE

Twisted Nylon



Bulk	Display	A (Dia.)	B (Length)	C (Eye Size)	Color	WLL-kgs/lbs	B.S.-kgs/lbs	Wt.(lb.)	Std. Pack
n/a	301112030BK-1	1/2"	30'	12"	Black	415/915	2080/4200	.52	6 ea
n/a	301112030BL-1	1/2"	30'	12"	Blue	415/915	2080/4200	.52	6 ea
n/a	301112030WH-1	1/2"	30'	12"	White	415/915	2080/4200	.52	6 ea
n/a	301116050WH-1	5/8"	50'	15"	White	900/1980	4500/9100	.75	4 ea
n/a	301119015BK-1	3/4"	15'	18"	Black	1060/2330	5300/10700	.55	6 ea
n/a	301119015WH-1	3/4"	15'	18"	White	1060/2330	5300/10700	.55	6 ea

Twisted Nylon Dock Lines

- 100% premium twisted three-strand nylon
- High strength with superior stretch for the shock loads of boat wakes and harbor surges
- Superior abrasion resistance to counteract chafe
- Professionally hand-spliced with five tucks
- Yacht whipped at the bitter end and splice point
- All lines are medium lay
- Comes in an attractive reclosable clamshell package

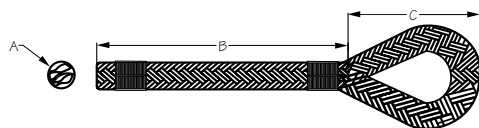

PREMIUM DOCK LINE

Double Braided Nylon

New Sizes!



Bulk	Display	A (Dia.)	B (Length)	C (Eye Size)	Color	WLL-kgs/lbs	B.S.-kgs/lbs	Wt.(lb.)	Std. Pack
n/a	302110010BG-1	3/8"	10'	12"	Burgundy	376/825	1880/3800	.35	12 ea
n/a	302112010BG-1	1/2"	10'	12"	Burgundy	438/960	2190/4400	.45	12 ea
n/a	302112035BK-1	1/2"	35'	12"	Black	438/960	2190/4400	.68	12 ea
n/a	302112035G/W-1	1/2"	35'	12"	Gold/White	438/960	2190/4400	.68	12 ea
n/a	302112035NV-1	1/2"	35'	12"	Navy	438/960	2190/4400	.68	12 ea
n/a	302112035WH-1	1/2"	35'	12"	White	438/960	2190/4400	.68	12 ea
n/a	302116035NV-1	5/8"	35'	15"	Navy	927/2045	4650/9400	.75	6 ea

Double Braided Nylon Dock Lines

- 100% premium double braided nylon
- Professionally spliced soft eye at one end
- Yacht whipped at the bitter end and splice point
- Available in a wide range of colors and sizes
- Comes in an attractive reclosable clamshell package



PREMIUM DOCK LINE WITH REFLECTIVE TRACER

Double Braided Nylon

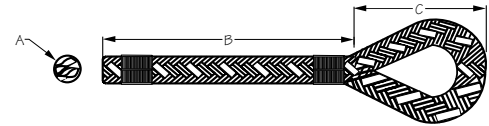

Bulk	Display	A (Dia.)	B (Length)	C (Eye Size)	Color	WLL-kgs/lbs	B.S.-kgs/lbs	Wt.(lb.)	Std. Pack
n/a	302110010BKT-1	3/8"	10'	12"	Black	376/825	1880/3800	.35	12 ea
n/a	302110010G/WT-1	3/8"	10'	12"	Gold/White	376/825	1880/3800	.35	12 ea
n/a	302110015BKT-1	3/8"	15'	12"	Black	376/825	1880/3800	.45	12 ea
n/a	302110015G/WT-1	3/8"	15'	12"	Gold/White	376/825	1880/3800	.45	12 ea
n/a	302110020BKT-1	3/8"	20'	12"	Black	376/825	1880/3800	.50	12 ea
n/a	302110020G/WT-1	3/8"	20'	12"	Gold/White	376/825	1880/3800	.50	12 ea
n/a	302112010BKT-1	1/2"	10'	12"	Black	438/960	2190/4400	.45	12 ea
n/a	302112010G/WT-1	1/2"	10'	12"	Gold/White	438/960	2190/4400	.45	12 ea
n/a	302112015BKT-1	1/2"	15'	12"	Black	438/960	2190/4400	.50	12 ea
n/a	302112015G/WT-1	1/2"	15'	12"	Gold/White	438/960	2190/4400	.50	12 ea
n/a	302112020BKT-1	1/2"	20'	12"	Black	438/960	2190/4400	.55	12 ea
n/a	302112020G/WT-1	1/2"	20'	12"	Gold/White	438/960	2190/4400	.55	12 ea
n/a	302116015BKT-1	5/8"	15'	15"	Black	927/2045	4650/9400	.60	6 ea
n/a	302116015G/WT-1	5/8"	15'	15"	Gold/White	927/2045	4650/9400	.60	6 ea
n/a	302116020BKT-1	5/8"	20'	15"	Black	927/2045	4650/9400	.60	6 ea
n/a	302116020G/WT-1	5/8"	20'	15"	Gold/White	927/2045	4650/9400	.60	6 ea

Double Braided Nylon Dock Lines with Tracer

- 100% premium double braided nylon with reflective tracers, visible up to 200 ft
- Professionally spliced soft eye and yacht whipped at the bitter end and splice point
- High-capacity tensile strength and excellent shock absorption capabilities
- Resistant to rot, abrasion, mildew, oil, UV rays, and can be stored wet or dry
- Comes in an attractive reclosable clamshell package



GAS TANK STRAP

Nylon Webbing/304 Stainless Steel

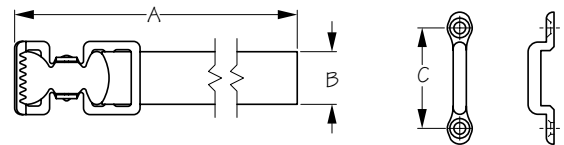

Bulk	Display	A	B	C	Fastener	Wt.(lb.)	Std. Pack
359995	359995-1	6'	1"	2-3/16"	#10 FH	.23	10 ea

For use in securing a portable gas tank. Strap kit includes: 1" X 6' Nylon webbing strap with 304 stainless steel buckle, two 304 stainless steel footman's loops and four #10 FH fasteners.



LED CABIN/READING LIGHT

Plastic

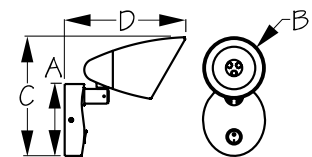

Bulk	Display	A	B	C	D	Voltage	Finish	Fastener	Wt.(lb.)	Std. Pack
n/a	400730-1	2-3/4"	2-5/8"	4-3/4"	4-1/4"	10-30	Silver	#6 FH	.22	5 ea

Features an adjustable light angle for directed lighting. G4 LED 2W (warm white) bulb included. Rated at 150 lumens.

⚠ WARNING: Cancer and Reproductive Harm - www.P65Warnings.ca.gov



LED SURFACE MOUNT COURTESY EDGE LIGHT

Stamped 304 Stainless Steel/Plastic

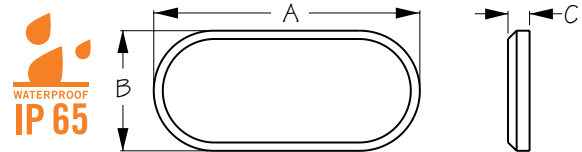

Bulk	Display	A	B	C	Voltage	Color	Fastener	Wt.(lb.)	Std. Pack
401375	401375-1	3-1/8"	1-7/16"	3/16"	12	White	#10 FH	.04	10 ea / 5 ea
401379	401379-1	3-1/8"	1-7/16"	3/16"	12	Blue	#10 FH	.04	10 ea / 5 ea

Constructed of 304 stamped stainless steel and lightweight plastic for corrosion resistance. These lights feature 3 low amperage, long life blue or warm white LEDs. Installs with two #10 FH fasteners (not included). IP65 waterproof rating.

⚠ WARNING: Cancer and Reproductive Harm - www.P65Warnings.ca.gov

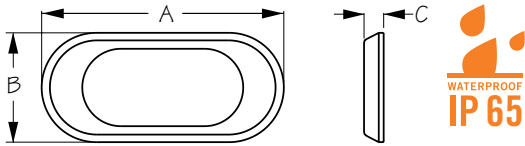

LED SURFACE MOUNT COURTESY LIGHT

Stamped 304 Stainless Steel/Plastic



Bulk	Display	A	B	C	Voltage	Color	Fastener	Wt.(lb.)	Std. Pack
401405	401405-1	3-1/8"	1-7/16"	3/16"	12	White	#10 FH	.05	10 ea / 5 ea
401409	401409-1	3-1/8"	1-7/16"	3/16"	12	Blue	#10 FH	.05	10 ea / 5 ea

Constructed of 304 stamped stainless steel and lightweight plastic for corrosion resistance. These lights feature 3 low amperage, long life blue or warm white LEDs. Installs with two #10 FH fasteners (not included). IP65 waterproof rating.

▲ **WARNING:** Cancer and Reproductive Harm - www.P65Warnings.ca.gov

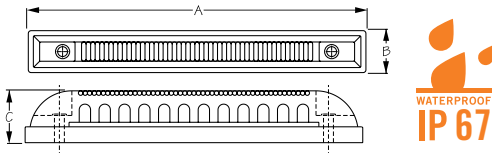

LED STRIP LIGHT

Plastic



Bulk	Display	A	B	C	LEDs	Voltage	Color	Fastener	Wt.(lb.)	Std. Pack
401447	401447-1	3-15/16"	3/4"	15/16"	6	12/24	Green	#10 RH	.06	5 ea
401448	401448-1	3-15/16"	3/4"	15/16"	6	12/24	Red	#10 RH	.06	5 ea
401465	401465-1	6"	3/4"	15/16"	12	12/24	White	#10 RH	.12	5 ea
401466	401466-1	6"	3/4"	15/16"	12	12/24	Blue	#10 RH	.12	5 ea
401467	401467-1	6"	3/4"	15/16"	12	12/24	Green	#10 RH	.12	5 ea
401468	401468-1	6"	3/4"	15/16"	12	12/24	Red	#10 RH	.12	5 ea

Constructed of corrosion resistant lightweight plastic. These lights feature 6 or 12 low amp draw LEDs per light. Installs with two #10 RH fasteners (included). Circuit boards are epoxy potted for a waterproof seal. IP67 waterproof rating. 12/24VDC.

▲ **WARNING:** Cancer and Reproductive Harm - www.P65Warnings.ca.gov

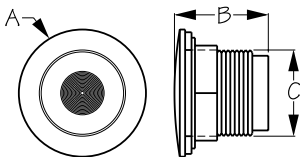

LED LIVEWELL LIGHT

Injection Molded Polycarbonate



Bulk	Display	A	B	C	Color	Wt.(lb.)	Std. Pack
n/a	401525B-1	1-1/2"	1-1/2"	7/8"	Blue	.05	5 ea

The LED livewell light is secured from the back by a threaded mounting ring. Injection molded polycarbonate construction this low-profile light features a water-resistant gasket and integral molded lens making it ideal for livewell applications.

▲ **WARNING:** Cancer and Reproductive Harm - www.P65Warnings.ca.gov

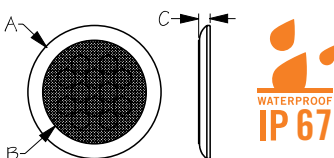

LED LOW PROFILE TASK LIGHT W/O SWITCH

Nickel Plated 304 Stainless Steel



Bulk	Display	A	B	C	Ring Finish	Voltage	LED Color	Fastener	Wt.(lb.)	Std. Pack
401665	401665-1	2-9/16"	1-3/8"	9/32"	Satin	12-24	White	#6 FH	.09	1 ea / 5 ea
401675	401675-1	3-3/8"	2-5/8"	9/32"	Satin	12-24	White	#6 FH	.12	1 ea / 5 ea

These low-profile task lights feature 6 warm white LEDs @ 0.2A / 100 lumens or 12 warm white LEDs @ 0.4A / 200 lumens. Does not have an integral on/off switch. 12/24VDC. IP67 waterproof rating.

▲ **WARNING:** Cancer and Reproductive Harm - www.P65Warnings.ca.gov



LED LOW PROFILE WHITE/BLUE TASK LIGHT

Nickel Plated 304 Stainless Steel

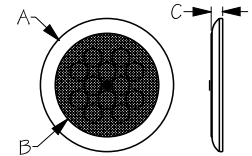

Bulk	Display	A	B	C	Ring Finish	Voltage	LED Color	Fastener	Wt.(lb.)	Std. Pack
401677	401677-1	3-3/8"	2-5/8"	9/32"	Satin	12-24	White/Blue	#6 FH	.12	1 ea / 5 ea

This low-profile task light features 12 LEDs; 8 warm white @ 0.19A / 143 lumens and 4 blue @ 0.11A / 29 lumens for night vision. Integral 3-way switch activates by pressing the center of the lens. Switch goes from on (Night)/off/on (Day). IP67 waterproof rating. CE approved. 12-24VDC.

⚠ WARNING: Cancer and Reproductive Harm - www.P65Warnings.ca.gov



LED LOW PROFILE DAY/NIGHT TASK LIGHT W/O SWITCH

Nickel Plated 304 Stainless Steel

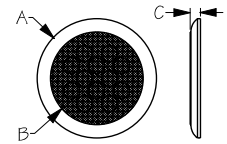

Bulk	Display	A	B	C	Ring Finish	Voltage	LED Color	Fastener	Wt.(lb.)	Std. Pack
401678	401678-1	3-3/8"	2-5/8"	9/32"	Satin	12-24	White/Red	#6 FH	.12	1 ea / 5 ea

This low-profile task light features 12 LEDs; 8 warm white @ 0.19A / 143 lumens and 4 red @ 0.06A / 43 lumens for night vision. Does not have an integral 3-way switch. IP67 waterproof rating. CE approved. 12-24VDC.

⚠ WARNING: Cancer and Reproductive Harm - www.P65Warnings.ca.gov



LED RECTANGULAR FLOOD LIGHT

Powder Coated Aluminum/Stamped 304 Stainless Steel Bracket

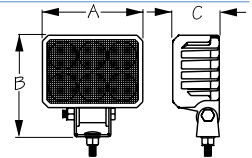

Bulk	Display	A	B	C	LEDs	Amps	Volts	Lumens	Wt.(lb.)	Std. Pack
n/a	405335-3	4-5/16"	4-1/8"	2"	6	1.4 A	9-36 V	1500	.99	1 ea

This marine grade LED flood light features 6 super bright LEDs and a stainless steel mounting bracket. IP67 waterproof rating.

⚠ WARNING: Cancer and Reproductive Harm - www.P65Warnings.ca.gov



LED SQUARE SPOT/FLOOD LIGHT

Powder Coated Aluminum/Stamped 304 Stainless Steel Bracket

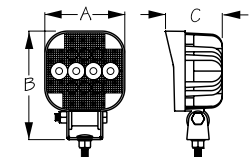

Bulk	Display	A	B	C	LEDs	Amps	Volts	Lumens	Wt.(lb.)	Std. Pack
n/a	405340-3	3-1/2"	4-3/4"	2-3/4"	10	1 A	9-36 V	1300	1.14	1 ea

This marine grade LED Spot/Flood light has 10 super bright LEDs and a stainless steel mounting bracket. IP67 waterproof rating.

⚠ WARNING: Cancer and Reproductive Harm - www.P65Warnings.ca.gov



HALOGEN SPOT LIGHT

ASA Plastic

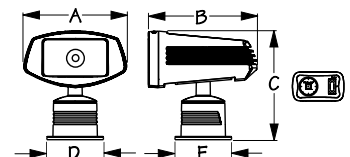

Bulk	Display	A	B	C	D	E	Spot Watts	Lumens	Wt.(lb.)	Std. Pack
n/a	405605-3	8-1/2"	8-1/2"	9-1/4"	4-3/4"	4-3/4"	55 W	1700	2.44	1 ea

Made from corrosion proof, impact resistant, and UV stabilized ASA plastic. Single speed motor. Includes joystick control panel and 15' wiring harness. 350° horizontal rotation range and 70° vertical range, with jam protection. Spotlight draws 4 amps and the motor draws 0.5 amps @ 12 volts. 1700 lumens. Joystick controller measures: 4-3/4" x 2-5/8". Uses H3 halogen bulb. IP65 rating.

⚠ WARNING: Cancer and Reproductive Harm - www.P65Warnings.ca.gov

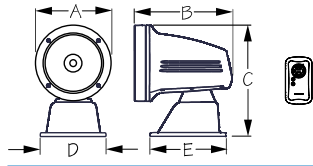

ASA HALOGEN SPOT/FLOOD LIGHT

ASA Plastic



Bulk	Display	A	B	C	D	E	Spot Watts	Flood Watts	Wt.(lb.)	Std. Pack
n/a	405610-3	6-11/16"	8-3/16"	9-5/8"	5-3/4"	6-5/8"	100 W	90 W	2.00	1 ea
405969	n/a	Replacement Bulb (H4 style)							.06	5 ea
n/a	405681-1	Battery Operated Wireless Remote Control for 405610-3							.35	1 ea
n/a	405691-1	12V Powered Wireless Second Control Station for 405610-3							.22	1 ea

This halogen spot/flood light features our control station remote #405691-1 as the primary controller, replacing the traditional joystick remote and RJ-11 phone cable connection. The 12 volt hardwired controller can be placed up to 100 ft (30 m) away from the light for wireless communication. Battery operated remote control #405681-1 sold separately. Single speed motor. 352° horizontal rotation range and 50° vertical range, with jam protection. Spot light draws 8.3 amps and the flood light draws 7.5 amps @ 12 volts. The motor draws 0.5 amps @ 12 volts. Uses H4 halogen bulb. 2500 lumens. IP67 waterproof rating. 5-year warranty.

▲ WARNING: Cancer and Reproductive Harm - www.P65Warnings.ca.gov

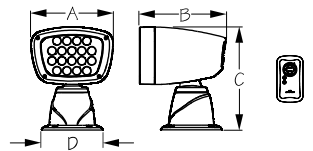

LED SPOT LIGHT

Powder Coated Aluminum



Bulk	Display	A	B	C	D	Voltage	Lumens	Wt.(lb.)	Std. Pack	
n/a	405626-3	7-7/8"	8-5/16"	9-15/16"	6"	12	4000	5.8	1 ea	
n/a	405683-1	Battery Operated Wireless Remote Control for 405626-3							.35	1 ea
n/a	405693-1	12V Powered Wireless Second Control Station for 405626-3							.22	1 ea

This LED spot light features our control station remote 405693-1 as the primary controller, replacing the traditional joystick remote and RJ-11 phone cable connection. The 12 volt hardwired controller can be placed up to 100 ft (30 m) away from the light for wireless communication. Battery operated remote control 405683-1 sold separately. Two speed motor. 355° horizontal rotation range and 50° vertical range, with jam protection. LED spot light draws 4 amps @ 12 volts. The motor draws 0.5 amps @ 12 volts. 4000 lumens. IP67 waterproof rating. 5-year warranty.

▲ WARNING: Cancer and Reproductive Harm - www.P65Warnings.ca.gov

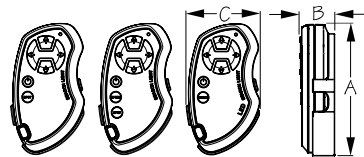

BATTERY OPERATED WIRELESS REMOTE CONTROL

Plastic



Bulk	Display	Description	A	B	C	Wt.(lb.)	Std. Pack
n/a	405681-1	Use with 405610-3	4"	1"	2-1/4"	.35	1 ea
n/a	405682-1	Use with 405620-3 & 405720-3	4"	1"	2-1/4"	.35	1 ea
n/a	405683-1	Use with 405626-3	4"	1"	2-1/4"	.35	1 ea

Replacement battery type, 23A-12V.

▲ WARNING: Cancer and Reproductive Harm - www.P65Warnings.ca.gov

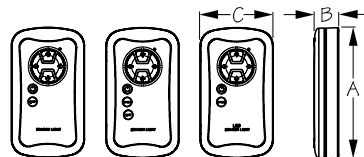

12V POWERED WIRELESS CONTROL STATION

Plastic



Bulk	Display	Description	A	B	C	Volts	Wt.(lb.)	Std. Pack
n/a	405691-1	Use with 405610-3	4-3/4"	7/8"	2-5/8"	12 V	.22	1 ea
n/a	405692-1	Use with 405620-3 & 405720-3	4-3/4"	7/8"	2-5/8"	12 V	.22	1 ea
n/a	405693-1	Use with 405626-3	4-3/4"	7/8"	2-5/8"	12 V	.22	1 ea

Provides wireless communication between the controller and light. Can be mounted up to 100 ft (30 m) from light source. 12 volt controller must be hardwired. Same footprint as joystick control for retrofit in older models.

▲ WARNING: Cancer and Reproductive Harm - www.P65Warnings.ca.gov



HALOGEN SPOT/FLOOD LIGHT

Cast 316 Stainless Steel/Stamped 316 Stainless Steel

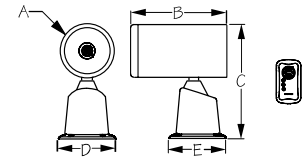

Bulk	Display	A	B	C	D	E	Spot Watts	Flood Watts	Wt.(lb.)	Std. Pack
n/a	405720-3	4-1/2"	8-1/4"	9-7/8"	4-3/4"	5-3/4"	100 W	90 W	4.00	1 ea
405969	n/a	Replacement Bulb (H4 style)							.06	5 ea
n/a	405682-1	Battery Operated Wireless Remote Control for 405720-3							.35	1 ea
n/a	405692-1	12V Powered Wireless Second Control Station for 405720-3							.22	1 ea

This halogen spot/flood light features our control station remote #405692-1 as the primary controller, replacing the traditional joystick remote and RJ-11 phone cable connection. The 12 volt hardwired controller can be placed up to 100 ft (30 m) away from the light for wireless communication. Battery operated remote control #405682-1 sold separately. Cast 316 stainless steel base with a stamped 316 stainless steel body and aluminum reflector for a classic, traditional look with a contemporary flair. Combination 100W/90W halogen bulb produces 165,000 CP spot/90,000 CP flood. Two speed motor. 350° horizontal rotation range and 55° vertical range, with jam protection. Spotlight draws 8.3 amps and the floodlight draws 7.5 amps @ 12 volts. The motor draws 0.5 amps @ 12 volts. Uses H4 halogen bulb. 2500 lumens. IP67 Waterproof rating. 5-year warranty.

⚠ WARNING: Cancer and Reproductive Harm - www.P65Warnings.ca.gov



MRV WIPER MOTOR

Stamped Powder Coated Steel/304 Stainless Steel

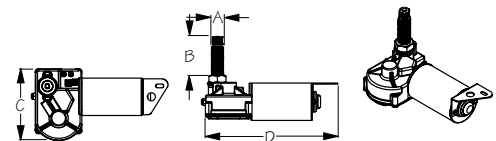

New 24V Motor!

Bulk	Display	Finish	Sweep	(Shaft Dia.)	(Shaft Len.)	C	D	Volts/Amps	Wt.(lb.)	Std. Pack
n/a	412171B-3	Black	110°	5/8"	2-1/2"	4"	7-1/4"	24/1	2.65	1 ea
n/a	412178B-3	Black	80°	5/8"	2-1/2"	4"	7-1/4"	24/1	2.65	1 ea

Two-speed, self-parking heavy-duty motors for interior/protected locations. Sweep angle is preset at 80° or 110°, but can be reset to 40°, 50°, 60°, 70°, 80°, 90° or 110°. Powder coated steel and aluminum housing with stainless steel mounting bracket, brass, and stainless steel shaft with brass knurled fitting. Adjustable right or left hand park, factory preset for left-hand park. Powers up to a 24" arm and blade configuration (36" total length). CE approved. 3-year warranty.

⚠ WARNING: Cancer and Reproductive Harm - www.P65Warnings.ca.gov



WATERPROOF HEAVY DUTY WIPER MOTOR

Powder Coated Aluminum/304 Stainless Steel

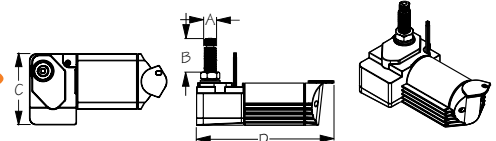

New 24V Motor!

Bulk	Display	Finish	Sweep	(Shaft Dia.)	(Shaft Len.)	C	D	Volts/Amps	Wt.(lb.)	Std. Pack
n/a	412261W-3	White	110°	5/8"	1-1/2"	4"	7-1/2"	24/1	3.20	1 ea
n/a	412268W-3	White	80°	5/8"	1-1/2"	4"	7-1/2"	24/1	3.20	1 ea
n/a	412271W-3	White	110°	5/8"	2-1/2"	4"	7-1/2"	24/1	3.20	1 ea
n/a	412278W-3	White	80°	5/8"	2-1/2"	4"	7-1/2"	24/1	3.20	1 ea

Two-speed, self-parking heavy-duty motors for exterior/unprotected locations. Sweep angle is preset at 80° or 110°, but can be reset to 40°, 50°, 60°, 70°, 80°, 90° or 110°. Powder coated all aluminum housing with stainless steel mounting bracket, shaft, and knurled fitting. Adjustable right or left hand park, factory preset for left-hand park. Powers up to a 24" arm and blade configuration (36" total length). IP66 rating. CE approved. 3-year warranty.

⚠ WARNING: Cancer and Reproductive Harm - www.P65Warnings.ca.gov



ADJUSTABLE WIPER ARM - HOOK STYLE

Powder Coated 304 Stainless Steel

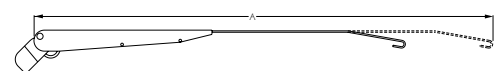

Bulk	Display	A	Shaft Size	Finish	Wt.(lb.)	Std. Pack
n/a	413168B-1	13"-18"	5/8"	Black	.57	10 ea
n/a	413174B-1	19"-24"	5/8"	Black	.65	10 ea

J-hook style. Fits all MRV and waterproof wiper motors with 5/8" shaft diameter. Compatible with 1.5" and 2.5" shafts.

ADJUSTABLE WIPER ARM - HOOK STYLE (ADJUSTABLE PIVOTING TIP)

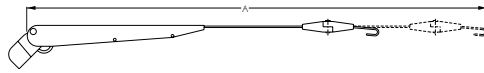

Powder Coated 304 Stainless Steel



Bulk	Display	A	Shaft Size	Finish	Wt.(lb.)	Std. Pack
n/a	413268B-1	13"-18"	5/8"	Black	.58	10 ea
n/a	413274B-1	19"-24"	5/8"	Black	.66	10 ea

J-hook style. The innovative adjustable tip allows blades to be set at different angles to maximize wiper blade coverage area and to ensure park position parallel to window frame. Fits all MRV and waterproof wiper motors with 5/8" shaft diameter. Compatible with 1.5" and 2.5" shafts.

ADJUSTABLE PANTOGRAPHIC WIPER ARM - HOOK STYLE

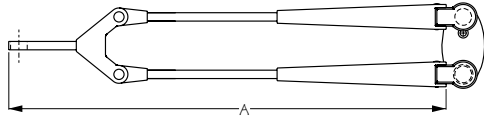

Powder Coated 304 Stainless Steel



Bulk	Display	A	Shaft Size	Finish	Wt.(lb.)	Std. Pack
n/a	413368B-1	13"-18"	5/8"	Black	1.36	1 ea
n/a	413374B-1	19"-24"	5/8"	Black	1.42	1 ea

J-hook style. Fits all MRV and waterproof wiper motors with 5/8" shaft diameter. Compatible with 1.5" and 2.5" shafts.

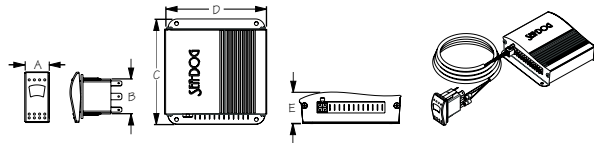

SYNCHRONIZED WIPER CONTROL

Powder Coated Aluminum/Stainless Steel



Bulk	Display	A	B	C	D	E	Voltage	Fastener	Wt.(lb.)	Std. Pack
n/a	414800-3	13/16"	1-7/16"	4-7/16"	4-3/8"	1-5/16"	12	#8 RH	1.40	1 ea

Synchronizer will sync up to three motors and adds an interval speed position to the traditional two-speed motor. One short push takes the motors from interval, to slow, then to fast speed. One long push activates the primary motor only. Capable of operating a washer system like the Sea-Dog® 414900-3. Kit includes: synchronized controller, switch, and 5' wiring harness. Overload protected. CE Approved.

▲ **WARNING:** Cancer and Reproductive Harm - www.P65Warnings.ca.gov

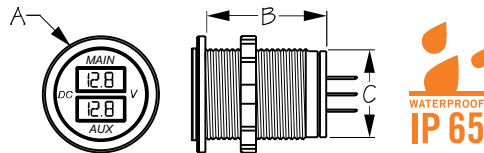

DUAL ROUND VOLTMETER

Injection Molded Nylon



Bulk	Display	A	B	C	Volts	Wt.(lb.)	Std. Pack
421616	421616-1	1-7/16"	1-3/8"	1-1/8"	10-48	.04	5 ea

This digital dual voltmeter displays voltage for main and auxiliary batteries simultaneously. The same compact size as a standard 1-1/8" socket allows this voltmeter to be installed in a wide variety of locations. Red LED display. Input 10V-48VDC. IP65 rating.

▲ **WARNING:** Cancer and Reproductive Harm - www.P65Warnings.ca.gov

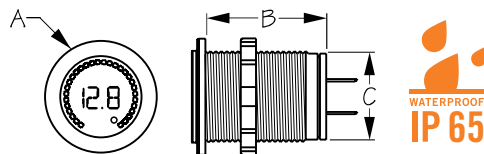

RAINBOW DISPLAY DIGITAL VOLTMETER

Injection Molded Nylon



Bulk	Display	A	B	C	Volts	Wt.(lb.)	Std. Pack
421617	421617-1	1-7/16"	3/4"	1-1/8"	5-15	.02	5 ea

The rainbow dial digital voltmeter gives the user quick visual color-coded voltage information. Red/yellow means the voltage is too low. Green means voltage is normal. The same compact round size as a standard 1-1/8" socket allows this voltmeter to be installed in a wide variety of locations. Rainbow LED display. For use with 12V systems. IP65 rating.

▲ **WARNING:** Cancer and Reproductive Harm - www.P65Warnings.ca.gov



DUAL VOLTMETER ROCKER SWITCH STYLE

Injection Molded Nylon

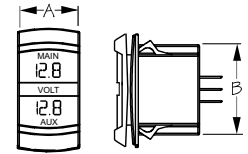

Bulk	Display	A	B	Volts	Wt.(lb.)	Std. Pack
421636	421636-1	13/16"	1-7/16"	10-48	.04	5 ea

This rocker switch style dual voltmeter monitors and displays the voltage for main and auxiliary batteries simultaneously. Fits into any 13/16" X 1-7/16" rocker switch hole. Digital red LED display. Input 10-48VDC. IP65 rating.

⚠ **WARNING:** Cancer and Reproductive Harm - www.P65Warnings.ca.gov



ROUND POWER SOCKET/METER MOUNTING BRACKET

Injection Molded Nylon

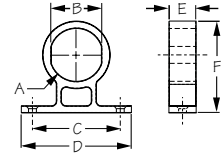

Bulk	Display	A	B	C	D	E	F	Fastener	Wt.(lb.)	Std. Pack
426105	426105-1	1-1/8"	1-1/16"	1-15/16"	2-3/8"	9/16"	1-15/16"	#8 FH	.02	10 ea / 5 ea

This injection molded nylon bracket is designed for the external mounting of round power sockets and gauges 1-1/8" in diameter. Fits all Sea-Dog® power sockets and meters.

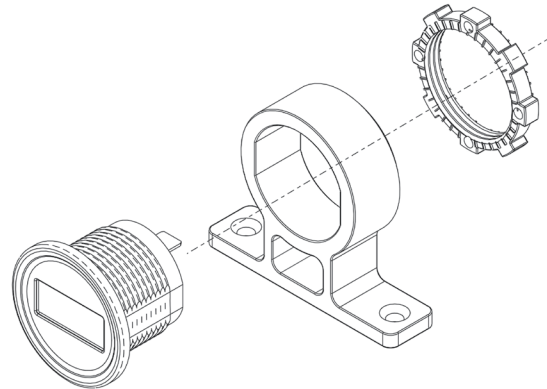

LED POWER SOCKET

Stamped Brass/Injection Molded Nylon & ABS

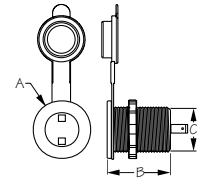

Bulk	Display	A	B	C	Volts	LEDs	LED Color	Wt.(lb.)	Std. Pack
426127	426127-1	1-7/16"	1-9/16"	1-1/16"	12-24	2	Blue	.08	5 ea

Add power easily almost anywhere. Drill a 1-1/8" hole, insert the socket body, tighten down the nut, connect the wires and you're done. 2 blue LEDs light up the interior. Input 12-24VDC. 16A. IP65 rating.

⚠ **WARNING:** Cancer and Reproductive Harm - www.P65Warnings.ca.gov



DOUBLE USB SOCKET/VOLTMETER W/ HIDDEN DISPLAY

Injection Molded Nylon

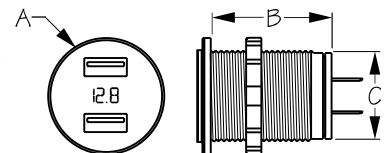

Bulk	Display	A	B	C	Volts	Total Output	Wt.(lb.)	Std. Pack
426517	426517-1	1-7/16"	1-1/2"	1-1/16"	12-24	5V/4.8A	.08	5 ea

This double USB socket allows for two devices to be charged simultaneously while also displaying the batteries output. The total output 4.8A load is split 2.4A per side as needed. Enough power to charge phones, pads, and tablets quickly and efficiently. Also fits Sea-Dog® power socket shell #426100. Input 12-24VDC. Output DC 5V/4.8A. Red LED display. IP65 rating.

⚠ **WARNING:** Cancer and Reproductive Harm - www.P65Warnings.ca.gov

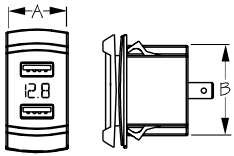

DOUBLE USB ROCKER SWITCH STYLE VOLTMETER W/ HIDDEN DISPLAY

Injection Molded Nylon



Bulk	Display	A	B	Volts	Total Output	Wt.(lb.)	Std. Pack
426527	426527-1	13/16"	1-7/16"	12-24	5V/4.8A	.05	5 ea

This double USB rocker switch style voltmeter fits into any standard 13/16" X 1-7/16" hole. Allows two devices to be charged simultaneously while also displaying the batteries output. The total output 4.8A load is split 2.4A per side. Enough power to charge phones, pads, and tablets quickly and efficiently. Input 12-24VDC. Output DC 5V/4.8A. Red LED display. IP65 rating.

▲ **WARNING:** Cancer and Reproductive Harm - www.P65Warnings.ca.gov

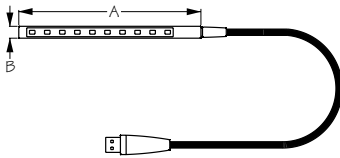

USB MAP LIGHT

Injection Molded Nylon/Powder Coated Steel



Bulk	Display	A	B	LEDs	Wt.(lb.)	Std. Pack
n/a	426560-1	5-3/4"	3/8"	10	.07	1 ea

Add light anywhere a USB port is present. This USB map light features 10 bright LEDs and a flexible 7" gooseneck that can rotate 360° illuminating any dark corner. A three function touch switch provides a full 10 bulb brightness mode as well as a 5 bulb half as bright mode. Light head is detachable for easy storage.

▲ **WARNING:** Cancer and Reproductive Harm - www.P65Warnings.ca.gov

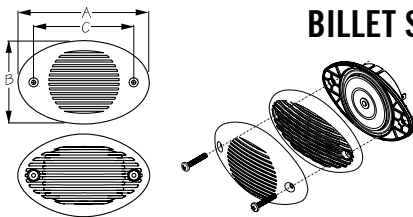

BILLET SCREW-IN GRILL COVER W/ SUB GRILL FOR #431255 HORN

304 Stainless Steel/ABS



Bulk	Display	Grill Finish	A	B	C	Wt.(lb.)	Std. Pack
431355	n/a	Stainless/Black	5-1/4"	3-3/8"	4"	.14	10 ea

Create a contemporary look for your #431255 horn. Set comes complete with one #431354 stainless grill and one #431353 ABS black plastic grill. Horn and screws not included.

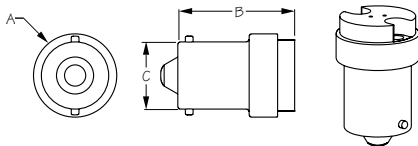

SINGLE CONTACT BAYONET BASE G4 ADAPTER

Nickel Plated Brass



Bulk	Display	A	B	C	Base Type	Wt.(lb.)	Std. Pack
n/a	442041-1	3/4"	1-1/16"	9/16"	BA15S	.01	5 ea

Adapts any G4 bi-pin style halogen bulb to a BA15S single contact bayonet base for use in standard marine light sockets.

▲ **WARNING:** Cancer and Reproductive Harm - www.P65Warnings.ca.gov

BOTTOM VIEW

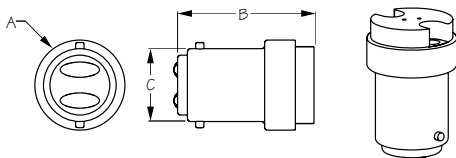

DOUBLE CONTACT BAYONET BASE G4 ADAPTER

Nickel Plated Brass



Bulk	Display	A	B	C	Base Type	Wt.(lb.)	Std. Pack
n/a	442042-1	3/4"	1-1/16"	9/16"	BA15D	.01	5 ea

Adapts any G4 bi-pin style halogen bulb to a BA15D double contact bayonet base for use in standard marine light sockets.

▲ **WARNING:** Cancer and Reproductive Harm - www.P65Warnings.ca.gov

BOTTOM VIEW





WARM WHITE LED G4 BASE BULB

Nickel Plated Brass/Plastic

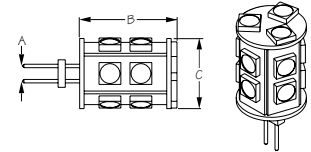

Bulk	Display	A	B	C	Lumens	Watts/Volts	Light Color	LEDs	Wt.(lb.)	Std. Pack
n/a	442642-1	4 MM	1"	5/8"	225	2/12	Warm White	13	.01	5 ea

These G4 bi-pin base lamps feature 13 high quality LEDs that produce 225 lumens. The equivalent of a 15-watt halogen bulb with an energy efficient 2-watt power consumption. These bulbs boast 360° omnidirectional light distribution and 50,000 life hours. For use with 12VDC systems only.

⚠ WARNING: Cancer and Reproductive Harm - www.P65Warnings.ca.gov



WARM WHITE LED G4 BASE BULB

Nickel Plated Brass/Plastic

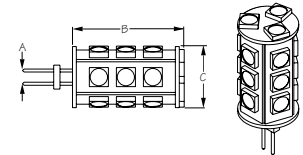

Bulk	Display	A	B	C	Lumens	Watts/Volts	Light Color	LEDs	Wt.(lb.)	Std. Pack
n/a	442643-1	4 MM	1-3/16"	5/8"	290	3/12	Warm White	18	.01	5 ea

These G4 bi-pin base lamps feature 18 high quality LEDs that produce 290 lumens. The equivalent of a 20-watt halogen bulb with an energy efficient 3-watt power consumption. These bulbs boast 360° omnidirectional light distribution and 50,000 life hours. For use with 12VDC systems only.

⚠ WARNING: Cancer and Reproductive Harm - www.P65Warnings.ca.gov



WARM WHITE LED HORIZONTAL G4 BASE BULB

Nickel Plated Brass/Plastic

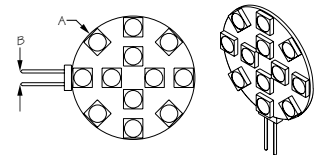

Bulk	Display	A	B	Base	Lumens	Watts/Volts	Light Color	LEDs	Wt.(lb.)	Std. Pack
n/a	442942-1	1-1/4"	4 MM	G4	200	2.4/12	Warm White	12	.01	5 ea

These G4 lamps feature 12 high quality LEDs that produce 200 lumens. Bi-pin base for easy plug and play installation. Mounted on one side of the disc, these LEDs offer direct 120° illumination with no wasted light. The equivalent of a 20-watt halogen bulb with an energy efficient 2.4-watt power consumption. Rated for 50,000 life hours. For use with 12VDC systems only.

⚠ WARNING: Cancer and Reproductive Harm - www.P65Warnings.ca.gov

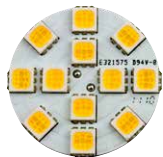

WARM WHITE LED VERTICAL G4 BASE BULB

Nickel Plated Brass/Plastic

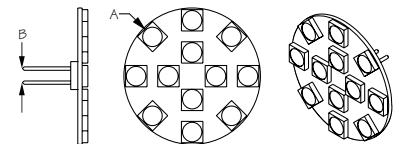

Bulk	Display	A	B	Base	Lumens	Watts/Volts	Light Color	LEDs	Wt.(lb.)	Std. Pack
n/a	442947-1	1-1/4"	4 MM	G4	200	2.4/12	Warm White	12	.01	5 ea

These G4 lamps feature 12 high quality LEDs that produce 200 lumens. Bi-pin base for easy plug and play installation. Mounted on one side of the disc, these LEDs offer direct 120° illumination with no wasted light. The equivalent of a 20-watt halogen bulb with an energy efficient 2.4-watt power consumption. Rated for 50,000 life hours. For use with 12VDC systems only.

⚠ WARNING: Cancer and Reproductive Harm - www.P65Warnings.ca.gov



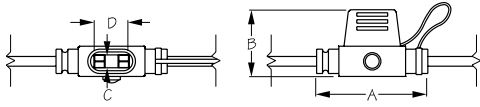

ATM MINI STYLE INLINE LED FUSE HOLDER

Injection Molded PVC



Bulk	Display	A	B	C	D	Max. Amps	Wire/Length	Wt.(lb.)	Std. Pack
n/a	445097-1	1-9/16"	15/16"	3/16"	1/2"	30	14 ga/12"	.04	5 ea

ATM mini style inline LED fuse holder for use with ATM mini style fuses 445002-1 thru 445030-1. LED indicator lights up when the fuse is blown. IP67 waterproof rating.

⚠ **WARNING:** Cancer and Reproductive Harm - www.P65Warnings.ca.gov

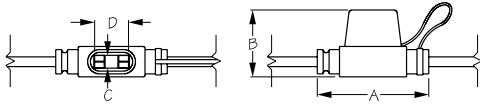

ATM MINI STYLE INLINE FUSE HOLDER

Injection Molded PVC



Bulk	Display	A	B	C	D	Max. Amps	Wire/Length	Wt.(lb.)	Std. Pack
n/a	445098-1	1-9/16"	15/16"	3/16"	1/2"	30	14 ga/12"	.03	5 ea

ATM Mini Style Inline Fuse Holder for use with ATM Mini Style Fuses 445002-1 thru 445030-1. IP67 waterproof rating.

⚠ **WARNING:** Cancer and Reproductive Harm - www.P65Warnings.ca.gov

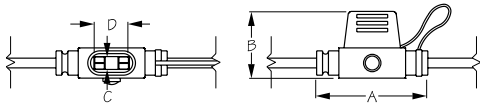

ATO/ATC STYLE INLINE LED FUSE HOLDER

Injection Molded PVC



Bulk	Display	A	B	C	D	Max. Amps	Wire/Length	Wt.(lb.)	Std. Pack
n/a	445197-1	1-1/4"	1"	3/16"	3/4"	30	14 ga/12"	.05	5 ea

ATO/ATC Style Inline LED Fuse Holder for use with ATO/ATC Style Fuses 445101-1 thru 445140-1. LED indicator lights up when the fuse is blown. IP67 waterproof rating.

⚠ **WARNING:** Cancer and Reproductive Harm - www.P65Warnings.ca.gov

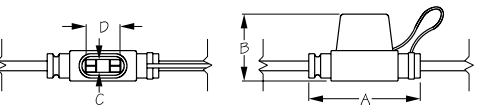

ATO/ATC STYLE INLINE FUSE HOLDER

Injection Molded PVC



Bulk	Display	A	B	C	D	Max. Amps	Wire/Length	Wt.(lb.)	Std. Pack
n/a	445198-1	1-1/4"	1"	3/16"	3/4"	30	14 ga/12"	.05	5 ea

ATO/ATC Style Inline Fuse Holder for use with ATO/ATC Style Fuses 445101-1 thru 445140-1. IP67 waterproof rating.

⚠ **WARNING:** Cancer and Reproductive Harm - www.P65Warnings.ca.gov

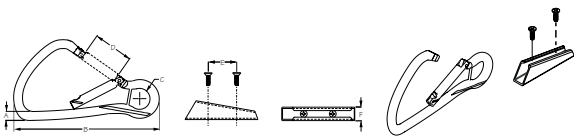

LARGE BOAT HOOK MOORING BUOY SNAP KIT

Investment Cast 316 Stainless/304 Stamped Stainless Steel



Bulk	Display	A	B	C	D	E	F	Fastener	Wt.(lb.)	Std. Pack
n/a	491058-1	1/2"	8-1/8"	1-3/16"	2-1/2"	1-11/16"	3/4"	#8 FH	1.27	5 ea

The safe and easy solution for attaching a mooring line to a mooring buoy or cleat. This snap fits onto the end of boat hooks or other poles, using the included backing plate, turning a challenging task into a quick and simple process. The kit includes the snap hook, keeper plate and fasteners for attaching the keeper plate (Sea-Dog® boat hooks have pre-drilled holes for ease of installation).

Truly a life saver on high bowed vessels. Simply reach out with the boat pole, hook the carabiner on the inside of the attachment point, then pull back on the boat pole. The carabiner snaps shut as it slides free of the pole securely clipping to the mooring eye or cleat. The large size works on cleats up to 24"! WLL - 2,185 lbs.





SEA-DOG® BOAT POLE

Injection Molded Nylon/Aluminum

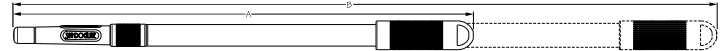

Bulk	Display	A	B	Style	Wt.(lb.)	Std. Pack
n/a	491112-1	48"	n/a	1 piece	.40	10 ea
n/a	491134-1	36"	96"	3 piece	.90	10 ea

The marine grade aluminum tubing, Acme threaded end attachment and comfort grip handle make for a high quality and durable accessory. Its buoyant design keeps the boat pole afloat for more than 5 minutes. The bright orange rubber tip cover is highly visible and removes for accessory attachment. Fits all Sea-Dog® boat hook accessories.



CAPTIVE GARBOARD DRAIN & PLUG

Investment Cast 316 Stainless Steel

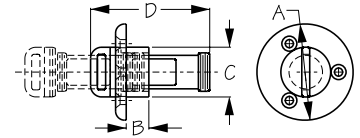

Bulk	Display	Description	Wt.(lb.)	Std. Pack
520068	n/a	Replacement Plug and Gasket Only	.15	5 ea

Replacement part for Captive Garboard Drain & Plug 520060 and 520065.



THRU-HULL

Injection Molded Polypropylene

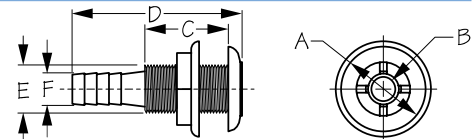

Bulk	Display	A	B	C	D	E	F	Color	Wt.(lb.)	Std. Pack
520750B	n/a	1-13/16"	1/2"	1-11/16"	3-1/2"	1"	3/4"	Black	.07	10 ea
520790B	n/a	2-7/8"	1-3/16"	2-5/16"	4-3/16"	1-13/16"	1-1/2"	Black	.23	10 ea

For use with hose to allow water to pass in or out of a vessel. These injection molded polypropylene thru-hulls are ideal for salt water use because they are impervious to electrolysis and corrosion. Designed for drainage above the water line.



MULTIPURPOSE CUTTER

Powder Coated Steel

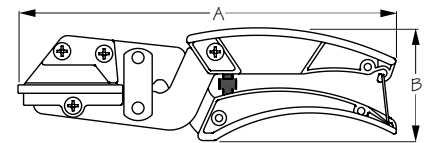

Bulk	Display	A	B	Wt.(lb.)	Std. Pack
n/a	563310-1	9-1/2"	2-5/8"	.73	1 ea

Multipurpose cutter is great for rope, wire and plastic tubing. Includes two spare utility blades stored in the handle.



HEAVY DUTY CANVAS & UPHOLSTERY SCISSORS

304 Stainless Steel/Injection Molded Nylon

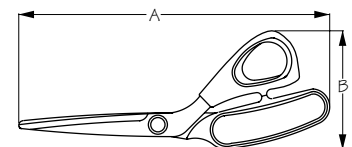

Bulk	Display	A	B	Wt.(lb.)	Std. Pack
n/a	563320-1	8-1/4"	3-1/4"	.24	1 ea

These quality stainless steel shears are designed with offset handles to allow the blades to hug the work surface giving you clean and precise cutting characteristics with both thin and thick materials. Heavy duty stainless steel blade for optimum performance and long-lasting sharpness. Comfortable soft cushion grip and adjustable blade tension to reduce fatigue. Fine serrated blade with precision ground edge ensures effortless cutting. Ideal for all heavy duty cutting including: rubber, vinyl, leather, plastics, cordage, upholstery, Kevlar and canvas.



SEA-DOG® BOTTLE OPENER

Investment Cast 316 Stainless Steel

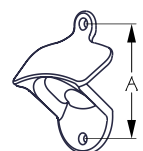

Bulk	Display	A	Fasteners	Wt.(lb.)	Std. Pack
588450SD	588450SD-1	2-3/8"	#6 FH	.17	10 ea

Corrosion resistant investment cast 316 stainless steel bottle opener wall mounts with two #6 FH fasteners (not included).











IP RATING CHART

(ingress) (protection)

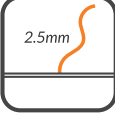
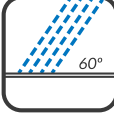
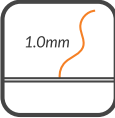
The IP Rating Chart provides a standard for the measuring of degree of protection against intrusion of solids and liquids. The first digit in an IP rating represent the degree in protection against solids, while the second represents degree of protection against liquids.

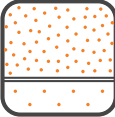
EXAMPLE

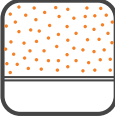
SOLID	+	LIQUID
6		7
Dust tight. Zero ingress of dust permitted.		Protected against the effects of immersion between 15cm and 1m

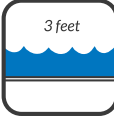
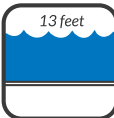
SOLID	+	LIQUID
<p>1 Protected against a solid object greater than 50 mm, such as a hand.</p> 		<p>1 Protected against water drops.</p> 
<p>2 Protected against a solid object greater than 12.5 mm, such as a finger.</p> 		<p>2 Protected against water drops at a 15° angle.</p> 
<p>3 Protected against a solid object greater than 2.5 mm, such as a wire.</p> 		<p>3 Protected against water spray at 60° angle.</p> 
<p>4 Protected against a solid object greater than 1.0 mm, such as a wire.</p> 		<p>4 Protected against water splashing from any angle.</p> 
<p>5 Dust protected. Prevents ingress of dust sufficient to cause harm.</p> 		<p>5 Protected against water jets from any angle.</p> 
<p>6 Dust tight. Zero ingress of dust permitted.</p> 		<p>6 Protected against powerful water jets and heavy seas.</p> 
		<p>7 Protected against the effects of temporary submersion in water. (30 mins at 3 feet)</p> 
		<p>8 Protected against the effects of permanent submersion in water. (Up to 13 feet)</p> 



EXPERIENCE THE SEA-DOG DIFFERENCE

A. PO Box 479
Everett, WA 98206
P. 425-259-0194
F. 425-339-1345
W. Sea-Dog.com

SEADOG LINE
QUALITY MARINE GEAR